



DOCUMENT NUMBER AND REVISION
VL-FS-MDLS16163-04 REV. B
(MDLS16163-LED01)

DOCUMENT TITLE:
SPECIFICATION
OF
LCD MODULE TYPE

MODEL NO.: MDLS16163-04

DEPARTMENT	NAME	SIGNATURE	DATE
PREPARED BY	HELEN HE	Helen He	2004.02.17
CHECKED BY	YU HAO	Yuhao	2004.02.17
APPROVED BY	DERRICK TAM	Derrick Tam	2004.2.17

DISTRIBUTION LIST: MARKETING



DOCUMENT REVISION HISTORY 1:

DOCUMENT REVISION FROM TO	DATE	DESCRIPTION	CHANGED BY	CHECKED BY
A	2000.02.04	First Release	PHILIP CHENG	K.P.HO
A B	2004.02.10	Items 1 to 4 were updated: (Based on the test specification: VL-TS-MDLS16163-04, REV. A, 2001-02-28). 1.) (Page 5, Figure 1) Outline Drawing was updated. 2.) (Page 7, Point 4.2) Environmental Condition was updated. 3.) (Page 8, Table 5) Supply voltage (LCD), Supply Current (Logic & LCD) & Supply Current (LCD) were updated. 4.) (Page 9, Point 5.2) Operating Temperature was updated. 5.) (Page 12, Point 6) Correspondence between Character Codes and Character Patterns was added.	HELEN HE	YU HAO



CONTENTS

	<u>Page No.</u>
1. GENERAL DESCRIPTION	4
2. MECHANICAL SPECIFICATIONS	4
3. INTERFACE SIGNALS	6
4. ABSOLUTE MAXIMUM RATINGS	7
4.1 ELECTRICAL MAXIMUM RATINGS (Ta=25°C)	7
4.2 ENVIRONMENTAL CONDITION	7
5. ELECTRICAL SPECIFICATIONS	8
5.1 TYPICAL ELECTRICAL CHARACTERISTICS	8
5.2 TIMING SPECIFICATIONS	9
5.3 TIMING DIAGRAM OF VDD AGAINST V0	11
6. CORRESPONDENCE BETWEEN CHARACTER CODES AND CHARACTER PATTERNS (NOVATEK STANDARD NT3881D-01)	12

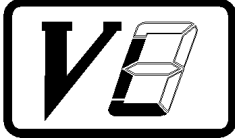

VARITRONIX LIMITED

Specification of LCD Module Type Model No.: MDLS16163-04

1. General Description

- 16 characters (5 x 8 dots) x 1 line STN Positive Yellow Transflective LCD Character Module.
- Viewing Angle: 6 O'clock direction.
- Driving duty: 1/16 Duty, 1/5 bias.
- 'NOVATEK' NT3881DH-01/AI (die form) LCD Controller and Driver or equivalent.
- Yellow-green LED01 backlight.

2. Mechanical Specifications

The mechanical detail is shown in Fig. 1 and summarized in Table 1 below.

Table 1

Parameter	Specifications	Unit
Outline dimensions	53.0(W) x 20.0(H) x 8.0 MAX(D)	mm
Viewing area	36.0(W) x 10.0(H)	mm
Display format	16 characters x 1 line	-
Character size	1.85(W) x 3.15(H) (5 x 8 dots)	mm
Character spacing	0.30(W)	mm
Character pitch	2.15(W) x 3.15(H)	mm
Dot size	0.33(W) x 0.35(H)	mm
Dot spacing	0.05(W) x 0.05(H)	mm
Dot pitch	0.38(W) x 0.40(H)	mm
Weight:	TBD	grams

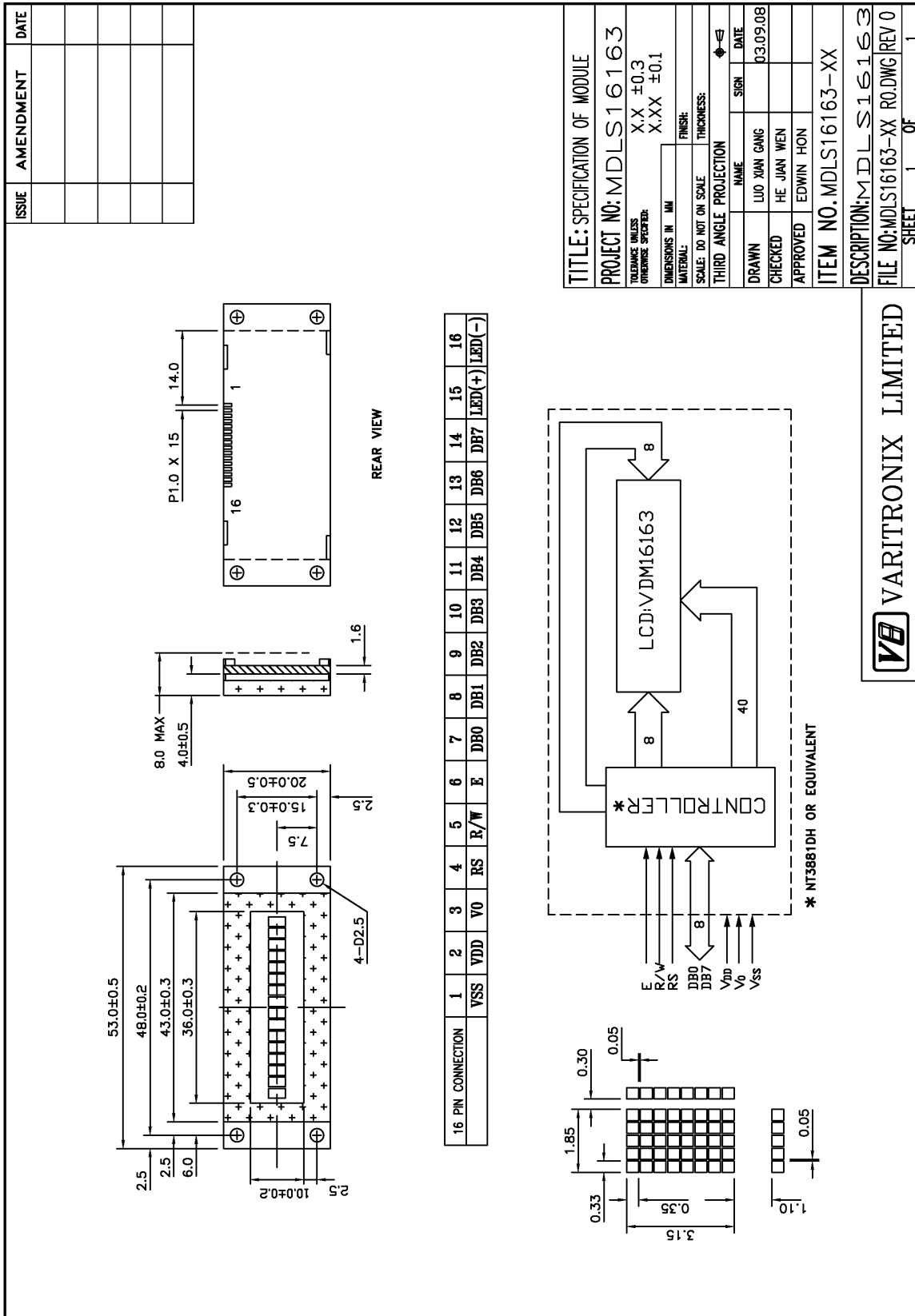

VARI TRONIX LIMITED

Figure 1: Outline Drawing

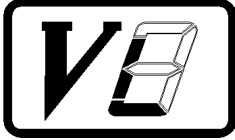

3. Interface signals

Table 2

Pin No.	Symbol	Description
1	VSS	Ground (0V).
2	VDD	Power supply for logic (+5V)
3	V0	Power supply for LCD driver
4	RS	Register Select Input: “High” for Data register (for read and write) “Low” for Instruction register (for write), Busy flag, address counter (for read)
5	R/W	Read/Write signal: “High” for Read mode. “Low” for Write mode.
6	E	Enable. Start signal for data read /write.
7	DB0	Data input/output (LSB)
8	DB1	Data input/output
9	DB2	Data input/output
10	DB3	Data input/output
11	DB4	Data input/output
12	DB5	Data input/output
13	DB6	Data input/output
14	DB7	Data input/output (MSB)
15	LED(+)	Anode of LED backlight
16	LED(-)	Cathode of LED backlight



4. Absolute Maximum Ratings

4.1 Electrical Maximum Ratings (Ta = 25 °C)

Table 3

Parameter	Symbol	Min.	Max.	Unit
Power Supply voltage (Logic)	VDD – VSS	-0.3	+7.0	V
Power Supply voltage (LCD drive)	VLCD=VDD – V0	-0.3	+13.5	V
Input voltage	Vin	-0.3	VDD +0.3	V

Note:

The modules may be destroyed if they are used beyond the absolute maximum ratings.

All voltage values are referenced to VSS = 0V.

4.2 Environmental Condition

Table 4

Item	Operating Temperature (Topr)		Storage Temperature (Tstg)		Remark
	Min.	Max.	Min.	Max.	
Ambient Temperature	-20°C	+70°C	-30°C	+80°C	Dry
Humidity	95% max. RH for Ta ≤ 40°C < 95% RH for Ta > 40°C				no condensation
Vibration (IEC 68-2-6) cells must be mounted on a suitable connector	Frequency: 10 ~ 55 Hz Amplitude: 0.75 mm Duration: 20 cycles in each direction.				3 directions
Shock (IEC 68-2-27) Half-sine pulse shape	Pulse duration : 11 ms Peak acceleration: 981 m/s ² = 100g Number of shocks : 3 shocks in 3 mutually perpendicular axes.				3 directions



5. Electrical Specifications

5.1 Typical Electrical Characteristics

At $T_a = 25\text{ }^\circ\text{C}$, $V_{DD} = 5V \pm 5\%$, $V_{SS} = 0V$.

Table 5

Parameter	Symbol	Conditions	Min.	Typ.	Max.	Unit
Supply voltage (Logic)	VDD-VSS		4.75	5.00	5.25	V
Supply voltage (LCD)	VLCD =VDD-V0	VDD =5.0V, Note1.	4.75	5.00	5.25	V
Input signal voltage for E,DB0-DB7,R/W,RS.	V _{IH}	“H” level	2.2	-	VDD	V
	V _{IL}	“L” level	-0.3	-	0.8	V
Input signal voltage 2 for OSC1	V _{IH2}	“H” level	VDD- 1.0	-	VDD	V
	V _{IL2}	“L” level	VSS	-	1.0	V
Supply Current (Logic & LCD)	IDD	Character mode, Note 1	-	1.41	2.11	mA
		Checker board mode, Note 1	-	1.61	2.41	mA
Supply Current (LCD)	I0	Character mode, Note 1	-	0.57	0.86	mA
		Checker board mode, Note 1	-	0.57	0.86	mA
Supply voltage of yellow-green LED01 backlight	VLED01	Forward current =2x10=20mA Number of LED chips=2 X 2 = 4.	3.8	4.1	4.5	V

Note 1: There is tolerance in optimum LCD driving voltage during production and it will be within the specified range.

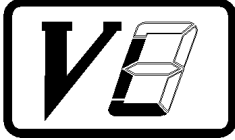

5.2 Timing Specifications

At $T_a = -20\text{ }^\circ\text{C}$ To $+70\text{ }^\circ\text{C}$, $V_{DD} = +5V \pm 5\%$, $V_{SS} = 0V$.

Refer to [Fig. 2](#), the bus timing diagram for write mode.

Table 6

Parameter	Symbol	Min.	Max.	Unit	Remarks
Enable cycle time	t_{CYCE}	500	-	ns	
Enable "High" level pulse width	t_{WHE}	300	-	ns	
Enable rise time	t_{RE}	-	25	ns	
Enable fall time	t_{FE}	-	25	ns	
RS, R/W set-up time	t_{AS}	60	-	ns	8-bit operation mode
		100			4-bit operation mode
RS, R/W address hold time	t_{AH}	10	-	ns	
Data output delay	t_{DS}	100	-	ns	
Data hold time	t_{DHR}	10	-	ns	

Refer to [Fig. 3](#), the bus timing diagram for read mode .

Table 7

Parameter	Symbol	Min.	Max.	Unit	Remarks
Enable cycle time	t_{CYCE}	500	-	ns	
Enable "High" level pulse width	t_{WHE}	300	-	ns	
Enable rise time	t_{RE}	-	25	ns	
Enable fall time	t_{FE}	-	25	ns	
RS, R/W set-up time	t_{AS}	60	-	ns	8-bit operation mode
		100			4-bit operation mode
RS, R/W address hold time	t_{AH}	10	-	ns	
Read data output delay	t_{RD}	-	190	ns	
Read data hold time	t_{DHR}	20	-	ns	

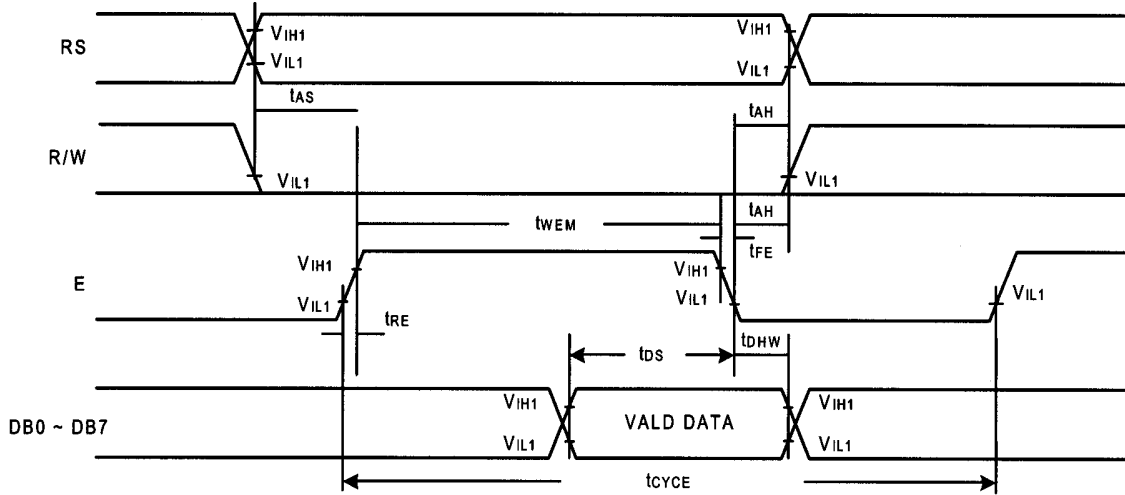

Figure 2: Bus write operation sequence (Writing data from MPU to NT3881D).

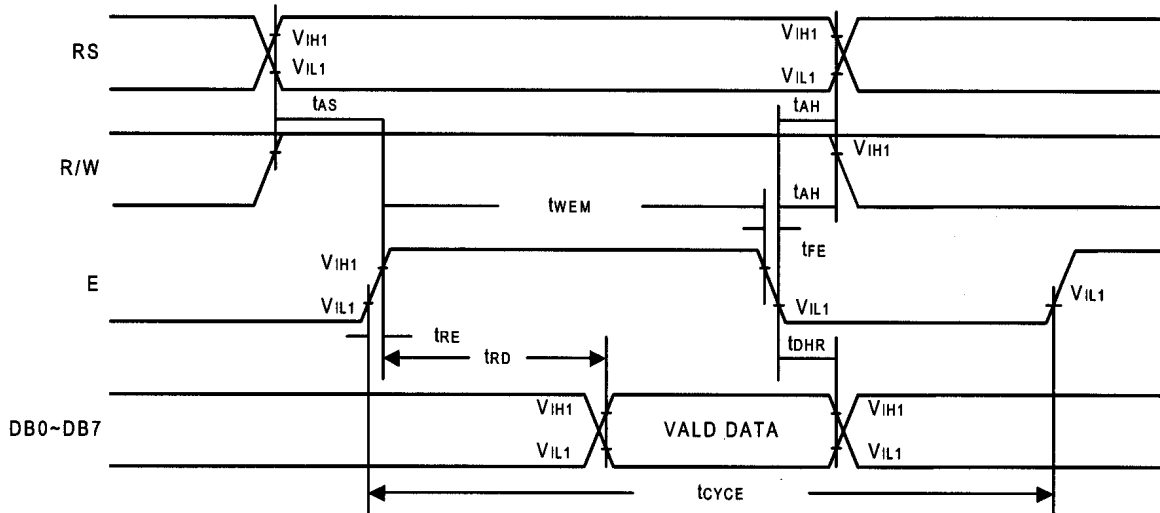

Figure 3: Bus read operation sequence (Reading out data from NT3881D to MPU).



5.3 Timing Diagram of VDD against V0.

Power on sequence shall meet the requirement of Figure 4, the timing diagram of VDD against V0.

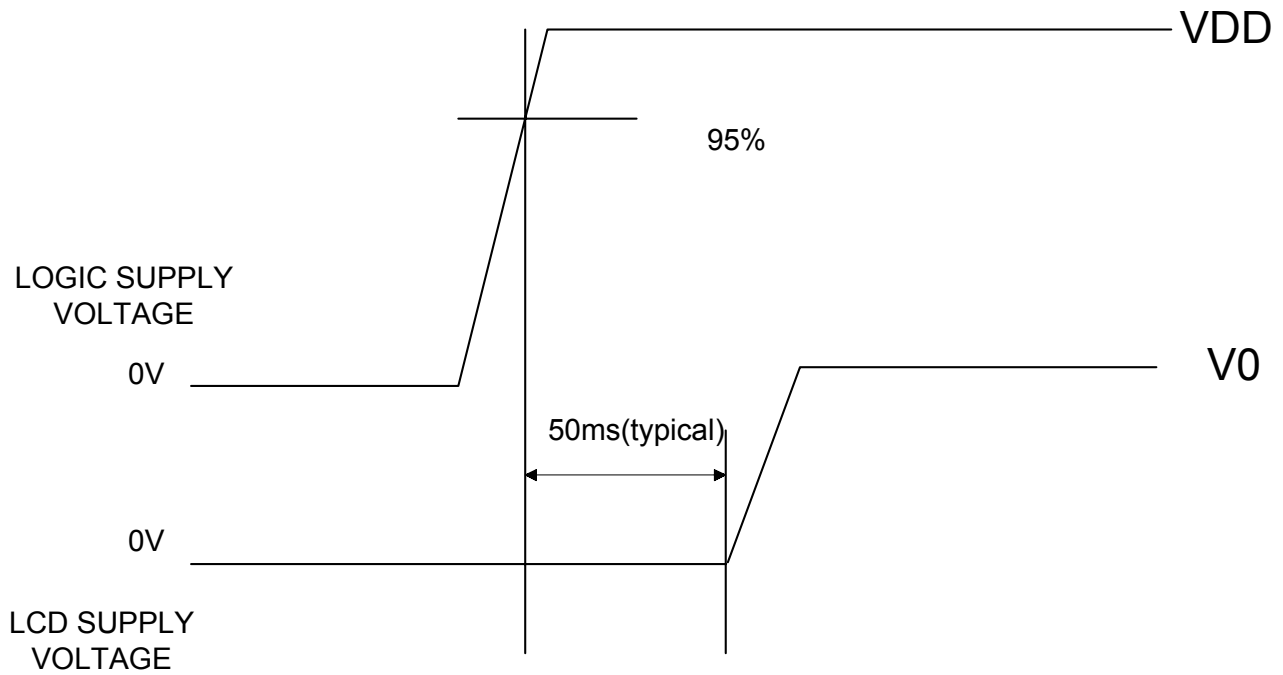
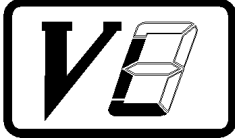

Figure 4: Timing diagram of VDD against V0.



6. Correspondence between Character Codes and Character Patterns
(NOVATEK Standard NT3881D-01)

		Higher 4-bit (D4 to D7) of Character Code (Hexadecimal)															
		0	1	2	3	4	5	6	7	8	9	A	B	C	D	E	F
Lower 4-bit (D0 to D3) of Character Code (Hexadecimal)	0	CG RAM (1)			0	Q	P	`	P				一	9	3	0	P
	1	CG RAM (2)		!	1	A	Q	a	9			。	ア	チ	4	3	9
	2	CG RAM (3)		"	2	B	R	b	r			「	イ	ツ	×	β	θ
	3	CG RAM (4)		#	3	C	S	c	s			」	ウ	テ	モ	ε	ω
	4	CG RAM (5)		\$	4	D	T	d	t			、	エ	ト	ト	μ	Ω
	5	CG RAM (6)		%	5	E	U	e	u			。	オ	ナ	1	2	Ü
	6	CG RAM (7)		&	6	F	V	f	v			ヲ	カ	ニ	ヨ	ρ	Σ
	7	CG RAM (8)		'	7	G	W	g	w			フ	キ	ヌ	ラ	9	π
	8	CG RAM (1)		(8	H	X	h	x			イ	ク	ネ	リ	5	×
	9	CG RAM (2))	9	I	Y	i	y			ウ	ケ	ル	ル	、	4
	A	CG RAM (3)		*	:	J	Z	j	z			エ	コ	ン	レ	j	〒
	B	CG RAM (4)		+	;	K	C	k	c			オ	サ	ヒ	ロ	*	万
	C	CG RAM (5)		,	<	L	¥	l	l			カ	シ	フ	ワ	φ	円
	D	CG RAM (6)		-	=	M	∫	m	∫			ユ	ズ	、	、	ト	÷
	E	CG RAM (7)		.	>	N	^	n	→			ヨ	セ	ホ	、	ん	
	F	CG RAM (8)		/	?	O	_	o	+			ッ	リ	マ	°	ö	

“Varitronix Limited reserves the right to change this specification.”

FAX: (852) 2343-9555.

URL: <http://www.varitronix.com>